

Compact Dual-band Reach Xtend™ (FR05-01-NO-1-004) – AN for Bluetooth Headsets and WiFi Headsets. 2.4-2.5 GHz and 4.9-5.875 GHz

Fractus Antennas specializes in enabling effective mobile communications. Using Fractus technology, we design and manufacture optimized antennas to make your wireless devices more competitive. Our mission is to help our clients develop innovative products and accelerate their time to market through our expertise in antenna design, testing and manufacturing.



Compact Dual-band Reach Xtend™

FR05-S1-NO-1-004

Fractus Antennas products are protected by [Fractus patents](#).

All information contained within this document is property of Fractus Antennas and is subject to change without prior notice. Information is provided “as is” and without warranties. It is prohibited to copy or reproduce this information without prior approval.

Fractus Antennas is an ISO 9001:2008 certified company. All our antennas are lead-free and RoHS compliant.



TABLE OF CONTENTS

1.	RECOMMENDED PCB LAYOUTS FOR A NEW DESIGN.....	3
1.1.	BLUETOOTH HEADSETS (2.4-2.5 GHZ)	3
1.2.	WIFI HEADSETS (2.4-2.5 GHZ AND 4.9-5.875 GHZ)	3
2.	MATCHING NETWORK IN FREE SPACE	4
3.	MATCHING NETWORK WITH HUMAN BODY EFFECT	4
4.	CAPABILITIES AND MEASUREMENT SYSTEMS.....	5

1. RECOMMENDED PCB LAYOUTS FOR A NEW DESIGN

The following examples describe the basics for a new design of a Bluetooth headset or a WiFi headset. Notice the importance of the antenna location, ground plane area, clearance area and the pads for a PI matching network (close to the antenna feeding point but in the ground plane area). All images below are not corresponding to real sizes.

1.1. BLUETOOTH HEADSETS (2.4-2.5 GHZ)

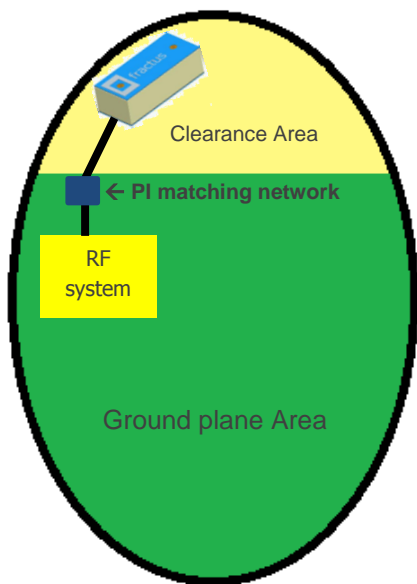

Example 1. With one FR05-S1-N-0-102 antenna

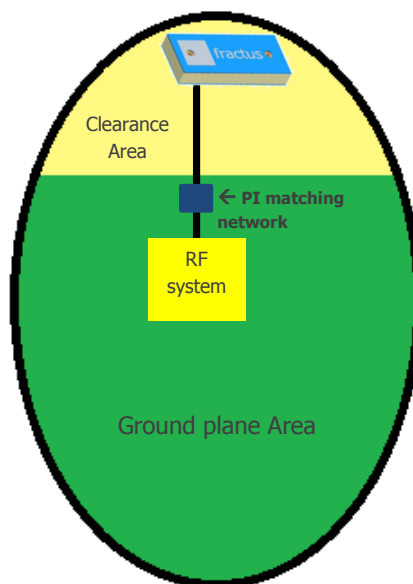

Example 2. With one FR05-S1-N-0-104 antenna

1.2. WIFI HEADSETS (2.4-2.5 GHZ AND 4.9-5.875 GHZ)

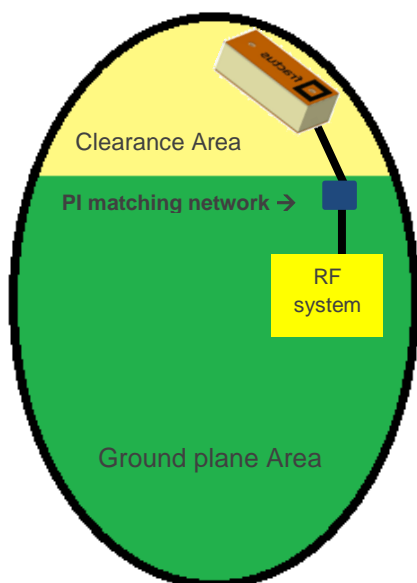

Example 3. With one FR05-S1-NO-1-004 antenna

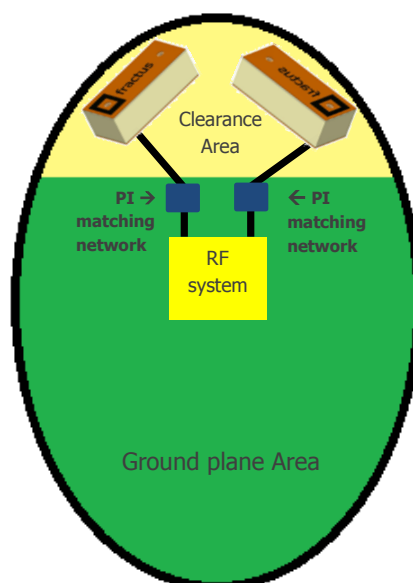

Example 4. MIMO with two FR05-S1-NO-1-004 antennas

2. MATCHING NETWORK IN FREE SPACE

The specs of a Fractus Antennas standard antenna are measured in their evaluation board (in free space), which is an ideal case. In a real design, components nearby the antenna, semiconductors, LCD's, batteries, covers, connectors, etc affect the antenna performance. This is the reason why it is highly recommended placing pads compatible with 0402 and 0603 SMD components for a PI matching network as close as possible to the antenna feeding point. Do it in the ground plane area, not in the clearance area. This is a degree of freedom to tune the antenna once the design is finished and taking into account all elements of the series (batteries, displays, covers, etc).

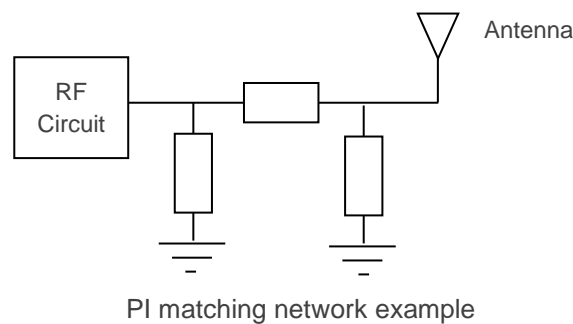

Please contact info@fractusantennas.com for more information related to the antenna matching service.

3. MATCHING NETWORK WITH HUMAN BODY EFFECT

The human body affects the performance of the antenna and produces a frequency downshift. Therefore the configuration of the matching network has to be designed with a phantom head to optimize the antenna performance.



Antenna efficiency measurement of a headset in an anechoic chamber (3D pattern integration). Test includes a phantom head.

Please contact info@fractusantennas.com for more information related to the antenna matching service with a phantom head.

4. CAPABILITIES AND MEASUREMENT SYSTEMS

Fractus Antennas specializes in the design and manufacture of optimized antennas for wireless applications, and with the provision of RF expertise to a wide range of clients. We offer turn-key antenna products and antenna integration support to minimize your time requirements and maximize return on investment throughout the product development process. We also provide our clients with the opportunity to leverage our in-house testing and measurement facilities to obtain accurate results quickly and efficiently.



Agilent E5071B

VSWR
&
S Parameters

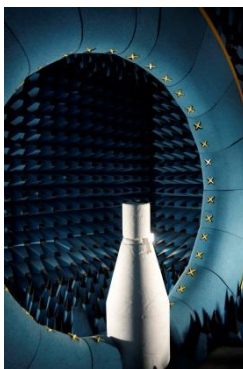
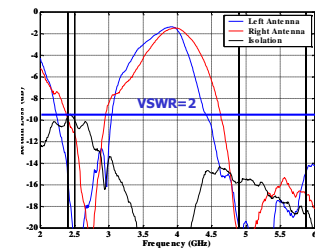

SATIMO STARGATE 32

Radiation
Pattern
&
Efficiency

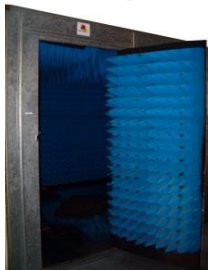
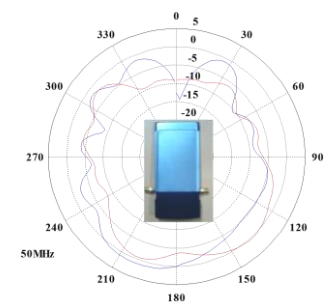

Anechoic chambers and full equipped in-house lab