

## Micro Reach Xtend™ (FR05-S1-N-0-110) – AN for Bluetooth Headsets and WiFi Headsets. 2.4-2.5 GHz

Fractus Antennas specializes in enabling effective mobile communications. Using Fractus Antennas technology, we design and manufacture optimized antennas to make your wireless devices more competitive. Our mission is to help our clients develop innovative products and accelerate their time to market through our expertise in antenna design, testing and manufacturing.



Micro Reach Xtend™

FR05-S1-N-0-110

Fractus Antennas products are protected by [Fractus patents](#).

All information contained within this document is property of Fractus Antennas and is subject to change without prior notice. Information is provided “as is” and without warranties. It is prohibited to copy or reproduce this information without prior approval.

Fractus Antennas is an ISO 9001:2008 certified company. All our antennas are lead-free and RoHS compliant.



## TABLE OF CONTENTS

1.	RECOMMENDED PCB LAYOUT FOR A NEW DESIGN .....	3
1.1.	BLUETOOTH OR WIFI (2.4-2.5 GHz) WITH THE MICRO REACH XTEND™ CHIP ANTENNA (FR05-S1-N-0-110) .....	3
1.2.	MATCHING NETWORK IN FREE SPACE .....	4
1.3.	VSWR AND EFFICIENCY .....	5
2.	MATCHING NETWORK CONSIDERING THE HUMAN BODY EFFECT .....	5
3.	CAPABILITIES AND MEASUREMENT SYSTEMS .....	6

## 1. RECOMMENDED PCB LAYOUT FOR A NEW DESIGN

The following example describes the basics for a new design of a Bluetooth handset or a WiFi handset single band. Notice the importance of the antenna location, ground plane area, clearance area and the pads for a PI matching network (close to the antenna feeding point but in the ground plane area). All images below are not corresponding to real sizes.

### 1.1. BLUETOOTH OR WIFI (2.4-2.5 GHz) WITH THE MICRO REACH XTEND™ CHIP ANTENNA (FR05-S1-N-0-110)

The ground plane area of the Micro Reach Xtend™ standard evaluation board (pages 4 and 5 of the [user manual](#)) has been extended to 120 mm x 60 mm. This area is in line with the average dimensions of the most popular smartphones available in the market.

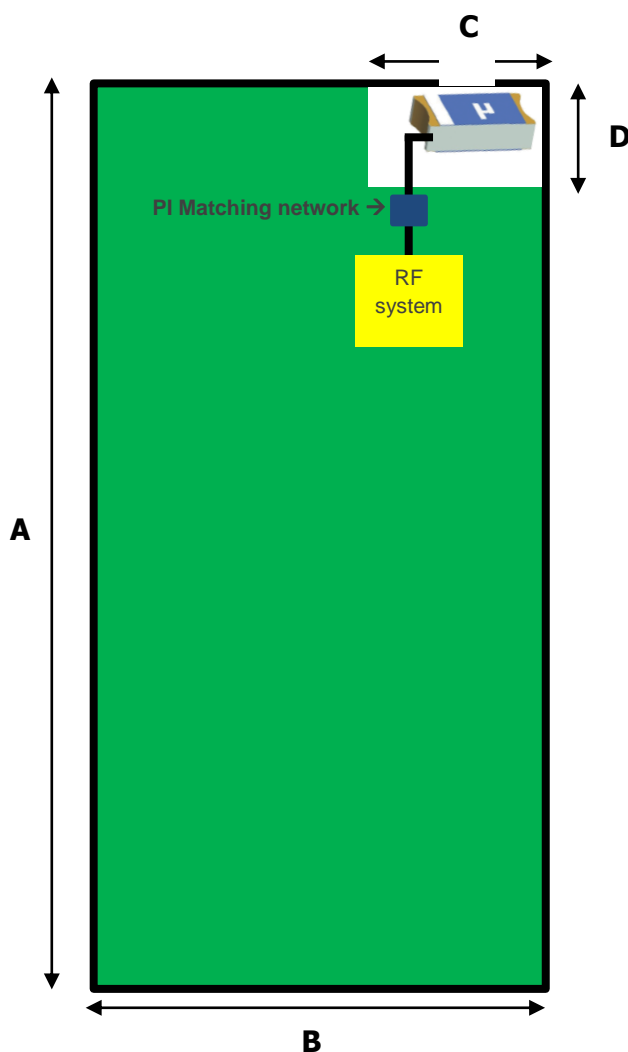

Measure	mm
A	120.0
B	60.0
C	7.5
D	5.0

Tolerance: ±0.2mm

**Note:** For recommended distances between the antenna and the ground plane please go to the [user manual](#) (Antenna Footprint, Figure 3, Page 8).

**Material:** The evaluation board is built on FR4 substrate. Thickness is 1 mm

Figure 1 – Example of the Micro Reach Xtend™ antenna in a 120 x 60 mm PCB.

## 1.2. MATCHING NETWORK IN FREE SPACE

The specs of a Fractus Antennas standard antenna are measured in their evaluation board (in free space), which is an ideal case. In a real design, components nearby the antenna, semiconductors, LCD's, batteries, covers, connectors, etc affect the antenna performance. This is the reason why it is highly recommended placing pads compatible with 0402 and 0603 SMD components for a PI matching network as close as possible to the antenna feeding point. Do it in the ground plane area, not in the clearance area. This is a degree of freedom to tune the antenna once the design is finished and taking into account all elements of the series (batteries, displays, covers, etc).

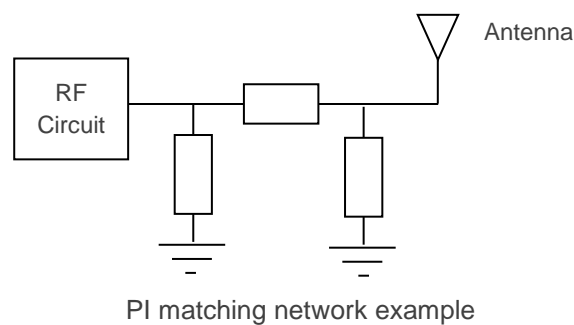

In the evaluation board showed in Figure 1 the values of the components are the following (0402 SMD, high-Q):

- Z1: Empty pad, no component
- Z2: 6.2 nH inductor
- Z3: 1.3 pF capacitor

To design a matching network in a new device, please contact [info@fracusantennas.com](mailto:info@fracusantennas.com) and request a quotation for the service.

### 1.3. VSWR AND EFFICIENCY

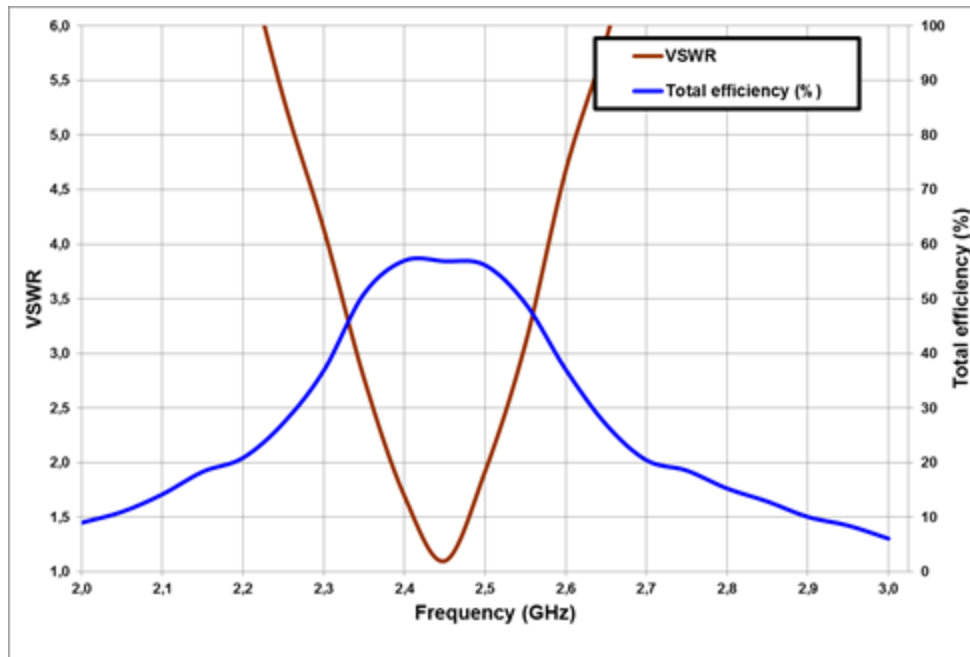

Figure 2 – VSWR (Voltage Standing Wave Ratio) and Efficiency (%) vs. Frequency.

The average efficiency across the 2.4 – 2.5 GHz band is around 56% while the average VSWR is around 1.6. In the 2.45 GHz frequency, the efficiency gets the peak of 57% and the VSWR gets the minimum value of 1.1.

Notice that the clearance area is the same in the standard Micro Reach Xtend™ evaluation board than in the 120 mm x 60 mm version. If the clearance area could be extended in the final design, then the performance of the antenna would be even better.

## 2. MATCHING NETWORK CONSIDERING THE HUMAN BODY EFFECT

The human head and hand affect the performance of the antenna and may produce a frequency downshift. Therefore the configuration of the matching network has to be designed with a phantom head and/or a phantom hand to optimize the antenna performance.

Please contact [info@fractusantennas.com](mailto:info@fractusantennas.com) for more information related to the antenna matching service with a phantom head and/or a phantom hand.

### 3. CAPABILITIES AND MEASUREMENT SYSTEMS

Fractus Antennas specializes in the design and manufacture of optimized antennas for wireless applications, and with the provision of RF expertise to a wide range of clients. We offer turn-key antenna products and antenna integration support to minimize your time requirements and maximize return on investment throughout the product development process. We also provide our clients with the opportunity to leverage our in-house testing and measurement facilities to obtain accurate results quickly and efficiently.

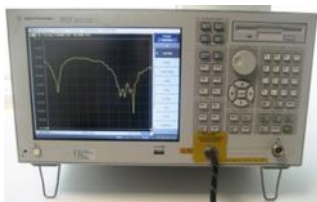

Agilent E5071B

VSWR  
&  
S Parameters

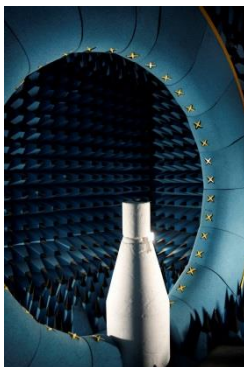
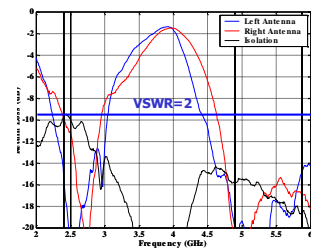

SATIMO STARGATE 32

Radiation  
Pattern  
&  
Efficiency

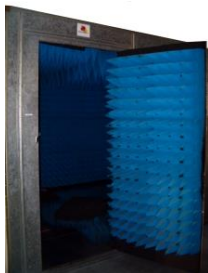
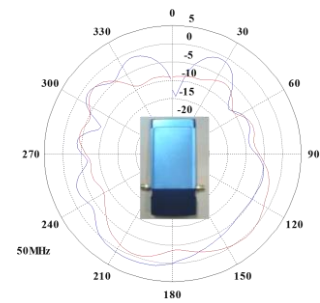

Anechoic chambers and full equipped in-house lab